

Elena Ongaretto ¹
Luca Pozza
Marco Savoia

WOOD-BASED SOLUTIONS TO IMPROVE QUALITY AND SAFETY AGAINST SEISMIC EVENTS IN CONSERVATION OF HISTORICAL BUILDINGS

Article info:
Received 14.12.2015
Accepted 02.02.2016

UDC – 54.061
DOI – 10.18421/IJQR10.01-01

Abstract: *Historical buildings can be highly vulnerable to earthquakes if in-plane strength and stiffness of floors and roofs are not sufficient to limit out-of-plane deformation of walls and to transmit the seismic forces among walls efficiently. In fact, floors and roofs in existing masonry buildings are normally realized with timber beams, purlins and a single layer of timber boards, and their in-plane stiffness can be limited when subjected to shear forces. Various retrofitting techniques are available, whose effectiveness can be very different and not easily predictable theoretically. In this paper, the behavior of different strengthening criteria for historical buildings, involving the use of wood and wood based products, is illustrated and critically discussed. Code provisions, design rules and calculation methods for strengthening interventions are described. In-plane behavior of floor and roof structures and their interaction and connection to the seismic resistant wall systems are considered. Finally, a case study of restoration intervention on a historic barn is presented, which was damaged during the 2012 earthquake in Emilia. The illustration is focused on the improvement of the whole safety of the construction by means of specifically designed interventions on the wooden roof.*

Keywords: *wooden floors, wooden roofs, masonry building, in-plane stiffness, seismic improvement, strengthening intervention*

1. Introduction

Seismic response of an unreinforced masonry (URM) building depends on several factors, such as in-plane and height regularity of the structure, masonry quality and texture, alignment of the openings and stiffness of nonstructural elements, just to name some of the most relevant. Seismic

response is strictly related to the building ability to behave as a box- structure. In fact, masonry walls typically have an insufficient resistance when loaded out-of-plane, and horizontal forces due to the floor movements must be carried out by the walls in the direction of the earthquake excitation (Piazza *et al.*, 2008; Giuriani *et al.*, 2008).

Tomazevic *et al.* (1992) conducted earthquake simulation tests on the role of different wooden floor structural systems in a two-story stone masonry building, pointing

¹ Corresponding author: Elena Ongaretto
email: elena.ongaretto@unibo.it

out its importance on the seismic overall resistance of the structure. Stiffness of wooden floors and roofs is fundamental to prevent excessive deformation in the floor plane and an insufficient transmission force mechanism. As an example, the wall collapse shown in Figure 1 is due to the insufficient stiffness at the roof level and the lack of the intermediate floor, necessary to prevent the out-of-plane collapse of the slender wall.



Figure 1. 2012 Emilia earthquake - Collapse of external slender walls due to the absence of the intermediate floor and insufficient stiffness at the roof level.

In-plane floor stiffness, necessary to prevent excessive deformability, also requires adequate connections between vertical walls and horizontal structures, in order to assure a correct transmission of shear forces to the lateral load resisting walls and prevent overturning of the transverse walls, the slipping of the wood beams from masonry supports and the consequent collapse of the floor or of the roof.

In traditional construction, including common buildings as well as historic architecture and monuments, timber elements have been used extensively for floors and roofs. Although timber diaphragm typologies differ significantly between countries, common behavior deficiencies of timber diaphragms and roofs can be

identified, that may result in detrimental global response of an unreinforced masonry building when subjected to an earthquake (Gattesco and Macorini, 2006). Typical shortcomings are: (1) localized damages due to biotic attack or static deficiencies; (2) absence of fasteners (i.e., nails, steel plates, etc..) against the loss of support and of connections between various timber elements and into carpentry joints (Figure 2a); (3) inadequate in-plane stiffness and strength of floors (Figure 2b); (4) inadequate shear transferring connections between floor (or roof) wooden structures and shear resistant masonries.

There are no standardized solutions suitable to improve and solve these shortcomings, intervention techniques on timber structures requiring be calibrated taking into account the specifically features of the buildings, the in-situ condition, etc... (DPCM 26.02.2011).

Techniques are inefficient in terms of structural efficiency, too invasive and slightly durable.

Typically, inappropriate interventions involve the refurbishment of the roof structure without realizing efficient curbs suitable to confer a box-like behavior to the building (Figure 3). On the other hand, realization of rigid and heavy concrete curbs, not efficiently connected to the roof structure or the masonry walls, are inappropriate: it may increase the roof weight (and then the seismic action) without avoiding the out-of-plane failure of the walls (Figure 4).

Considering the possible catastrophic effects of wrong restoration interventions, in the presence of wooden structures, special attention is required for improving strength and stiffness of floors and roof pitches against seismic loads. These interventions must also include the improvement of the shear transferring connections between floor or roof elements and masonry walls.

In addition, at the roof level, the rafters may cause the presence of a horizontal thrust on the walls, even in the presence of vertical loads only. The effect becomes of course

even worse and particularly critical in the presence of horizontal seismic loads and may cause very dramatic collapses (Figure 5). In fact, in the past timber roof structures were typically built to bear vertical loads only and without a formal design, with no provisions for responding to seismic actions.



a)



b)

Figure 2. 2012 Emilia earthquake - a) collapse due to the absence of connections between floor/roof diaphragms and masonry walls; b) collapse due to the absence of efficient floor and roof diaphragms



Figure 3. 2012 Emilia earthquake - Collapse due to a wrong intervention, without the realization of an upper curb on the masonry wall to distribute the horizontal forces transmitted by the new steel beams



a)



b)

Figure 4. Collapses due to wrong interventions, with realization of heavy and rigid concrete curbs not efficiently connected with the roof structure or the masonry walls: a) 2012 Emilia earthquake; b) 2009 Aquila earthquake

Hence, the first aspect to be considered is whether the roof structural scheme can assure an equilibrated path of forces in the presence of horizontal actions. Moreover, the roof system must be able to assure the necessary restraint at the upper level of the construction (Parisi and Piazza, 2015), in order to avoid perimeter wall overturning, especially in the case of masonry walls not properly connected (Figure 6).

In order to avoid the activation of these unfavorable out-of-plane wall mechanisms, the wooden roof can be strengthened to become the upper part of a box-structure: roof pitches are transformed into folded plates, which gather and transfer the roof seismic action to the shear resisting walls (Giuriani and Marini 2008). In addition, an effective connection of the upper portion of the walls at the roof springing level must be assured, which will: (1) absorb horizontal thrusts and transmit only vertical loads on the wall plane, (2) distribute possible concentrated loads; (3) inhibit the activation of out-of-plane overturning mechanisms of masonry walls.



Figure 5. 2012 Emilia earthquake - collapse due to unbalanced horizontal thrusts of roof structures



Figure 6. 2009 L'Aquila earthquake - wall detachment due to the absence of a roof structure capable of ensuring a box-like behavior of the church

In the present paper, the use of wood based techniques for seismic retrofitting of masonry buildings is critically presented and discussed. After an illustration of the structural behavior of masonry structures subject to earthquake actions, different retrofitting techniques, with different degrees of effectiveness and invasiveness, are presented. Some criteria to be met, when architectural preservation constraints are present due to the historic character of the construction, are also discussed. Appropriate calculation methods for strengthening interventions are also described, with reference to both code provisions and design

rules. A case study is finally presented, concerning the use of wooden solutions in restoration intervention for seismic strengthening on a historic barn damaged during 2012 Emilia earthquake.

2. Background on code provisions and regulations

The issue of seismic upgrading of historic buildings is of great relevance in many European countries, and some specifically developed rules and guidelines are available for design of structural restoration interventions.

2.1. General rules for intervention on historical buildings

In several regions of Italy, most of the buildings were built for lower levels of seismic action, or often even without any seismic provisions. For this reason, in every recent code, some prescriptions for improving safety of existing buildings are present. Current Italian code (D.M. 14.01.2008) requires that buildings undergoing some modification must be verified also against earthquake loadings. This rule aims at the progressive upgrading of the significant fraction of the building stock that was originally built without adequate consideration of seismic hazard. In this perspective, according to the categories commonly used in earthquake engineering, interventions for reduction of seismic vulnerability may be classified in: (1) seismic upgrading, which technically corresponds to design interventions such that the structure will be able to withstand the same design earthquake of exceptional level as a new building, is prescribed when the building is subject to major architectural renovation, or a change of use; (2) seismic improvement, which refers to less invasive, and sometimes local, interventions, is intended to eliminate possible critical issues without considering a full upgrading of the structural capacity, and can be considered in

the case of minor architectural interventions. According to the current codes, also in the case of seismic improvement the beneficial effect of the intervention on the structural capacity of the building must be technically assessed and computed.

It must be also remembered that, in historic masonry buildings, less invasive interventions to eliminate the most important vulnerabilities may give very good results in terms of reduction of seismic vulnerability (Giongo *et al.*, 2015).

Often, existing buildings with floor and roof timber structures belong to buildings listed as a part of the cultural heritage of a country. As such, they are also subjected to conservation requisites, and structural upgrading operations need to comply with both structural safety issues and conservation requirements when interventions on historic or monumental buildings must be designed and realized. In Italy, the most comprehensive regulatory document concerning the structural restoration of historic buildings are the “*Guidelines for the evaluation and reduction of seismic vulnerability of cultural heritage*” (DPCM 26.02.2011).

2.2. Detailing rules for wooden elements of existing buildings

Codes and standards listed in the previous paragraph list the steps of the structural diagnostics and describe the general approaches to design strengthening interventions on historic buildings, but without specific design guidelines for timber structures.

The issue of designing interventions on existing timber structures (typically wooden floors and roofs), with the aim of improving the structural interaction between timber floors/roofs and seismic resistant masonry walls, is very important and still not completely solved. Few indications can be found in structural design codes for general strengthening of existing timber structures,

especially when seismic resistance is of concern. As an example, Eurocode 8 (CEN, 2013) for earthquake resistant structural design does not refer to timber elements in Part 3 dealing with existing buildings, whereas Eurocode 5 concerning design of timber structures does not consider seismic issues.

Some of design criteria for new structures can be extended in some way for upgrading existing wooden structures. Accordingly, interventions should: (1) assure a well-defined and simple loading path for seismic forces; (2) maintain the timber elements in the elastic range and avoid local stress concentrations; (3) address special attention to joints, protecting them from sudden loss of capacity and brittle failure, and providing them with sufficient ductile capacity (Parisi and Piazza, 2015).

In the absence of specific regulation on historical wooden elements and structures, some standards were developed in the last years for design of strengthening interventions.

UNI standard 11119:2004 is the most important, addressing the steps of the restoration process of wooden elements, including criteria for in-situ inspection and diagnosis methodologies.

UNI standard 11138:2004 gives guidelines for a preliminary evaluation of the role of the timber structure within the building and, therefore, the definition of possible intervention strategies based on: (1) historical analysis of the building, (2) geometrical characterization of structural elements, (3) analysis of deteriorations, (4) material characterization, (5) structural analysis. The historical analysis must be based on the analysis of documents and material sources, including damage detection, disuse periods, demolitions or modifications during the building life. After a detailed geometric survey, the causes of the deformation of timber members must be investigated, verifying if they are due to excessive loadings and/or creep effects or

depend on material defects and deficiencies. Both biological deterioration and mechanical damages must be evaluated through a diagnostic campaign for material characterization carried out on each wooden member.

Finally, with the increasing use of innovative composite materials to improve the structural behavior of existing wooden structures, CNR -DT 201:2005 standard was developed, containing indications for strengthening of historic wooden elements, including guidelines for the execution phases of these, sometimes, sophisticated interventions.

3. Design criteria

The correct evaluation of forces acting on floor or roof diaphragms, as well as on connections with resistant wall system, is a fundamental issue in the design of strengthening intervention in historical buildings.

Different design criteria must be followed for floors and roofs, being two-dimensional and three-dimensional structures, respectively. However, some common design assumptions can be adopted, following Giuriani and Marini (2008).

First of all, resisting systems for vertical loads (e.g., gravitational) and horizontal loads (e.g., earthquake action) are decoupled. Dead and live gravity loads are supported by trusses, ridges and wooden principal beams, whereas horizontal loads are carried out by the whole masonry – wooden floor/roof system as a box-like structure.

The design criteria adopted for floors and roofs are illustrated separately in the following, and applied to the case study of a restoration intervention in Section 6.

3.1. Calculation of internal forces acting on floor diaphragms

First step is the identification of the masonry Wall Resisting Systems (WRS), followed by the calculation of the seismic forces at each

floor diaphragm level (D.M. 14.01.2008 or Eurocode 8 - CEN 2013).

Generally, the design, at least in the preliminary stage, is performed referring to equilibrium schemes disregarding the effect of the actual stiffness of the floor diaphragm.

The beam schematization of the floor diaphragm is the most common, providing directly the internal actions necessary for the design of all elements constituting the diaphragm and the connection systems.

In the beam scheme, the horizontal forces due to earthquake are considered as a distributed horizontal loading acting on the floor slab, where masses of both floor and masonry elements are computed. Then, the WRS realizing the horizontal supports of the floor diaphragm beam in both principal directions must be preliminarily defined.

Two different WRS configurations can be typically identified: isostatic or hyperstatic scheme (Giuriani and Marini, 2008), see for instance Figure 7. The double symmetric floor diaphragm in Figure 7a can be schematized as an isostatic beam with lateral supports in both x- and y-direction. On the contrary, the floor diaphragm in Figure 7b requires a hyperstatic schematization in y-direction, due to the presence of three resisting walls supporting the floor diaphragm when subject to horizontal forces.

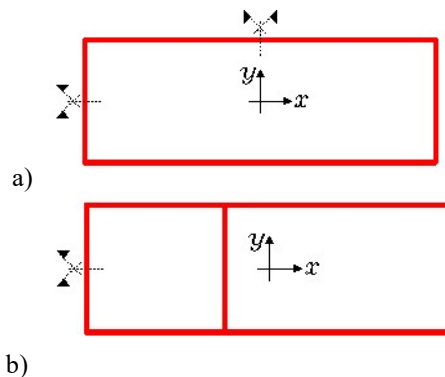

Figure 7. Examples of (a) isostatic and (b) hyperstatic WRS configurations in a masonry building

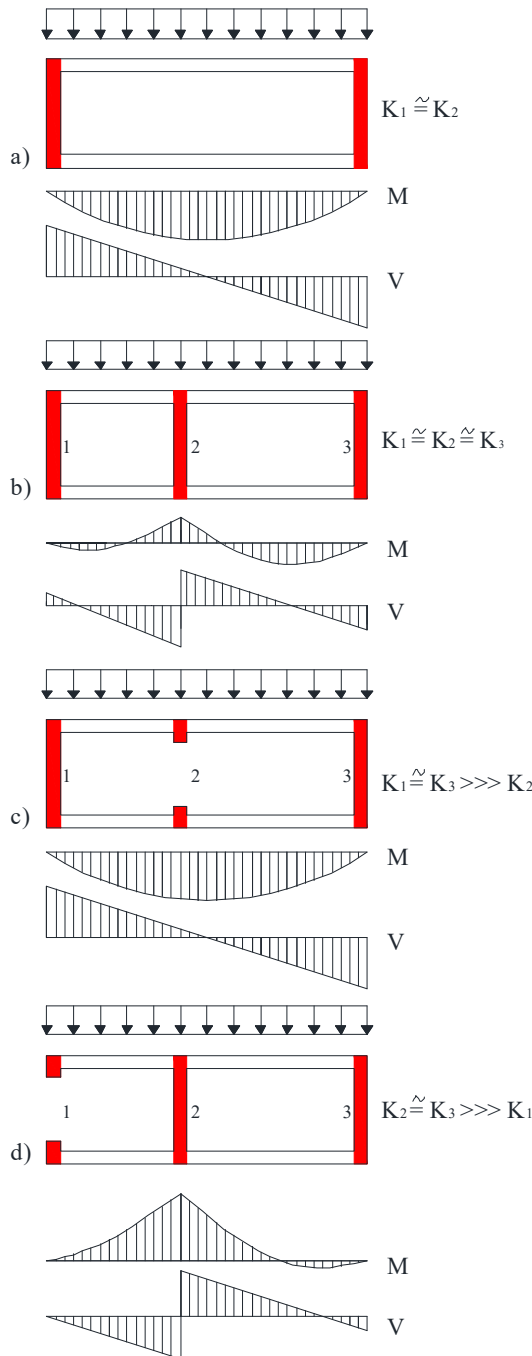

Figure 8. Examples of in-plane bending and shear diagrams for the floor diaphragm: (a) isostatic and (b-d) hyperstatic WRS configurations

Once the scheme of the in-plane floor beam is defined, the internal forces acting on it can be calculated. As an example, Figure 8 gives bending moment and shear acting on the floor diaphragm, for some typical WRS configuration. Solid red lines indicate the stiff solid walls providing for effective supports to the floor slab when subject to horizontal forces.

For isostatic schemes (Figure 8a), the force diagrams do not depend on the stiffness distribution among the masonry walls, whereas in the case of hyperstatic configurations, the internal force distribution depends on the stiffnesses of the elements. The wall stiffness may be strongly reduced by the presence of openings. Three different cases are reported in Figure 8 b-d.

If the walls are characterized by similar lateral stiffnesses, the horizontal floor beam is statically redundant, and the bending and shear distributions depend on the lateral wall stiffness as well as on the in-plane flexural and shear stiffnesses of the diaphragm (Figure 8b). On the contrary, in the presence of large openings, the wall stiffness is significantly reduced and sometimes can be neglected, giving rise to simpler isostatic schemes (see Figure 8 c, d).

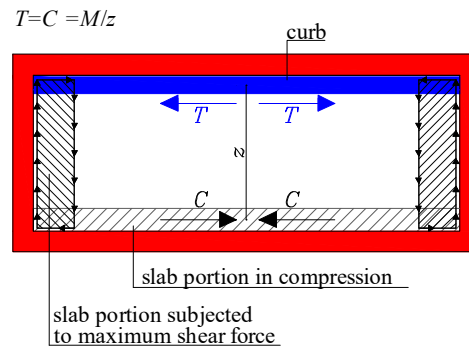

Figure 9. In-plane beam-like resisting system of a wood floor diaphragm. Design of floor/WRS connections.

The diaphragm resisting schemes and the consequent internal force distributions are

based on the hypothesis of rigid connection between floor and masonry wall resisting system (WRS). Therefore, the design of floor/WRS connections is crucial, and the schemes in Figure 9 can be adopted to calculate the design forces to be sustained by them. Connection elements are finally sized considering an overstrength factor, in order to avoid any possible failure as well as to ensure the deformability of the floor/WRS connections be negligible with respect to that of the floor diaphragm itself (Giuriani and Marini, 2008).

3.2. Design of the roof anti-seismic structure

The design of roof improvement interventions against seismic actions differs from the case of planar diaphragms due to the three-dimensional shape of the roof structure. Common steps are the definition of the Wall Resisting Systems (WRS), see Section 3.1, and the calculation of seismic forces acting at the roof level (D.M. 14.01.2008 or Eurocode 8 - CEN 2013).

The roof interventions must be exploited into two steps: a) strengthening of the pitches, b) definition of a tri-dimensional structural resisting system capable of ensuring an equilibrated path of force transmission between floor pitches and perimeter WRS.

The in-plane strengthening intervention of the roof pitches can be designed similarly to the floor case. In fact, the pitches must be transformed in sufficiently stiff diaphragms capable of transferring the seismic action to the WRS.

Once the pitches are strengthened and adequately connected with the walls, calculation of forces acting on roof elements requires the three-dimensionality of the roof structures be taken into account, with horizontal seismic forces on the roof acting in both transverse and longitudinal directions, for a typical two slope gable roof.

Consider the transverse direction of the roof in Figure 10, where the pitches are

strengthened and the seismic horizontal forces are transferred to the lateral resisting systems, typically two masonry gable walls. As reported in Figure 10, the masonry gables are subjected to both in-plane shear forces and overturning moment. The in-plane shear force induces a sliding effects on the gable with respect to the lower WRS, while the overturning moment may cause a rigid rotation of the gable with a consequent significant reduction of the vertical compression on one side and an increase of it on the opposite side. Such variation of the vertical loads could be dangerous for the structural stability of the upper part of the building under earthquake.

In the longitudinal direction, the roof structure behaves very differently. In this case, the pitches can be schematized as a beam simply-supported at the two extremities (see Figure 11a). Accordingly, the seismic longitudinal forces induce two relevant effects on the roof: a possible sliding of the entire coverage structure with respect to the WRS and a global in-plane deflection of the roof pitches with maximum displacement at the upper vertex of the gable. If the pitches are not sufficiently stiff in their planes, the large displacement of the roof top can cause the overturning of the masonry triangular gable (see Figure 11b).

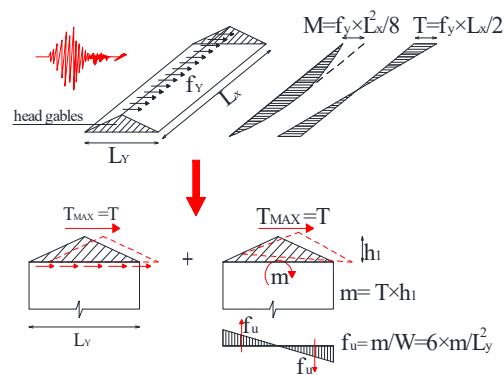

Figure 10. Roof subject to earthquake action in the transverse direction: scheme of forces acting on roof pitches and lateral gables.

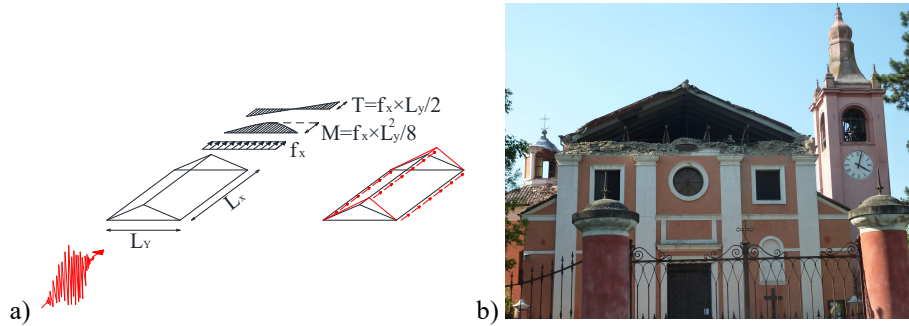

Figure 11. Roof subject to earthquake action in the longitudinal direction: a) scheme of roof forces acting on the pitches; b) collapse of the gable of a church

The proposed design schemes can be extended to more complex schemes, and allow to define the forces suitable for design the strengthening interventions on the roof pitches diaphragms in analogy with the criteria given for the floor diaphragms. In addition, the transmission forces between wooden structures and masonry walls can be defined and adopted for the design of the connection systems.

3.3. Remarks about the in-plane diaphragm stiffness

The approaches for design of floor and roof improvement interventions described in the previous sections consider only the bearing capacity of the structures. However, an adequate design of these interventions requires a deformation control for ensuring the adequate in-plane stiffness of floor or pitch diaphragms, necessary to avoid large out-of-plane displacement, and, therefore, the collapse of portions of masonry walls due to overturning mechanisms (Giuriani and Marini 2008).

Some specific guidelines about this issue are given in Section 4, where typical improvement interventions for floors and roof pitches diaphragms are presented and discussed, with reference to the attainable stiffness and strength level by adopting different technologies.

4. Structural rehabilitation techniques for wooden floors and roofs

Wooden floors and roof pitches of ancient buildings are usually both excessively deformable under service loads and not adequately stiff in their plane to adsorb out-of-plane forces acting on the masonries when subjected to earthquakes. Strengthening interventions are then required to increase bearing capacity and stiffness, both in-plane and out-of-plane (Gattesco *et al.*, 2006).

Inadequacies can be grouped into three categories: (1) out-of-plane (flexural) strength and stiffness deficiencies; (2) in-plane lack of stiffness; (3) inability to connect the load-bearing walls and to ensure a box-like behavior of the building.

Out-of-plane structural inefficiencies occur due to the limited flexural stiffness of beams under service loadings and give rise to macroscopically visible excessive deformation of the floors (hollows). Sometimes, insufficient strength can be due to material degradation or to new load requirements in the case of modifications of the building destination.

In-plane inefficiencies occur when stiffness and strength are insufficient to transfer the seismic action to the lateral resisting walls and to prevent out-of-plane overturning of the masonry walls.

Generally, global interventions allow to solve these structural deficiencies simultaneously. The rehabilitation techniques for existing floors and roof

itches must be chosen considering not only the wooden structural typology, but also the conservation status of the elements (UNI standard 11119:2004).

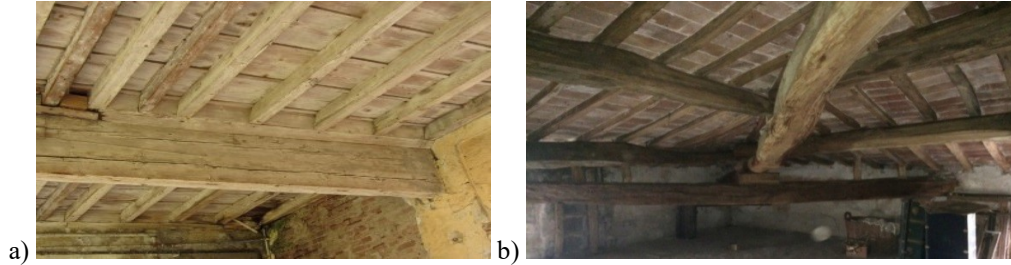

Figure 12. Common floor or pitch structural typologies: (a) wood planks nailed to the underlying rafters; (b) a layer of thin solid bricks resting on the rafters.

Table 1. Scheme of recurrent structural interventions for floors and roofs pitches

Type of reinforcement intervention	reversibility	technology	structure type	out-of-plane improvement	in-plane improvement
with reinforced concrete slab	NO	WET	FLOORS	YES	YES
with natural hydraulic lime slab reinforced with FRP mesh	YES	WET	FLOORS / ROOFS	NO	YES
with an additional layer of wood planks	YES	DRY	FLOORS / ROOFS	YES	YES
with multi-layered wood panels	YES	DRY	FLOORS / ROOFS	YES	YES
with steel profiles	YES	DRY	FLOORS / ROOFS	YES	YES
with Fiber Reinforced Polymers (FRP)	YES	WET-DRY	FLOORS / ROOFS	YES	YES

Two structural typologies for floors and roof pitches are widespread in Italian and European historic buildings (Figure 12): wood planks nailed to the underlying rafters, and a layer of thin solid bricks resting on the rafters (Corradi *et al.*, 2006). In the first case, some variants may exist, above all regarding the arrangement and shape of planks and rafters. Different techniques can be adopted to improve the in-plane and out-

of-plane stiffness and strength of existing floors or roof pitches, the most common are summarized in Table 1.

4.1. Reinforcement with R.C. slab

A strengthening technique widely used in the past decades consists in the realization of a Reinforced Concrete (RC) slab connected to the timber beams (Piazza and Turrini 1983;

Ronca *et al.*, 1991; Gattesco, 2001; Giuriani 2006). Typically, the 50 mm thick reinforced concrete slab is cast on the wood planks, and mechanical connectors are used to connect concrete slab to the wood beams, so realizing a composite section under bending. In the first applications of this technique (Piazza and Turrini, 1983), connection between timber beams and concrete slab was obtained with L shaped profiled rods fastened with epoxy to timber beams. Nowadays, different types of metallic fasteners, notched shear keys or perforated plates are used to assure connection between the two materials (Crocetti *et al.*, 2013). Depending on the connection stiffness (Figure 13), the behavior of the composite structure is intermediate between the two cases of two beams simply-supported one another and two beams perfectly connected. Calculation guidelines for this mixed wood-concrete structure are reported in Eurocode 5 (EN 1995-1, Eurocode 5).

As reported in some studies available in the literature (Gelfi and Giuriani, 1999), when boarding of the wood-concrete composite floors above the timber joists is not removed, a larger diameter for the dowels is needed in order to obtain the same connection stiffness and, therefore, the same global bending stiffness of the slab.

This “wet” improving technique is more suitable for floors and not efficient for roof strengthening, due to the significant weight increase. Advantages of this strengthening system are: increase of the load-carrying capacity and stiffness of the floor, better distribution of vertical loads among wooden beams, reduction of deflection and vibration underfoot, increase of sound insulation.

The behavior of the floor slabs against horizontal actions is determined by the concrete slab (much stiffer than the wood elements) and the efficient connections with the masonry walls, necessary to assure a box-like behavior of the building.

Major shortcomings concern the increase of weight, raising the seismic action and the

need for an extra depth over the existing decking, sometimes incompatible with the level of the floor. Moreover, this solution has low “reversibility” and high invasiveness, and is not often accepted in historical buildings, where restoration techniques must guarantee, as much as possible, maintenance of the building authenticity and integrity, conservation of the materials and of the original function of the structure, reversibility of the intervention and compatibility with the original parts of the buildings (Gubana, 2015).

Cross section:

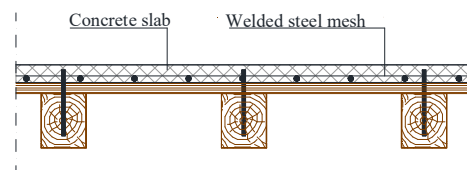

Longitudinal section:

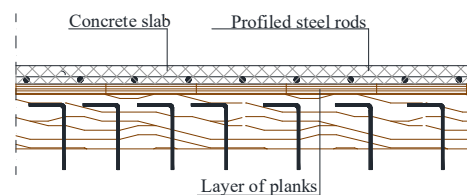

Figure 13. Transverse and longitudinal sections of a typical intervention of floor reinforcement with RC slab and steel connectors

In the last years, the interest in the adoption of “dry” strengthening techniques is raised, employing planks, timber panels, steel plates with thickness compatible with that of the floor (Giuriani, 2004). These solutions, belonging to the so-called “reversible” interventions, are detailed below.

4.2. Reinforcement with NHL slab

An alternative to RC slab involves the adoption of mortar with Natural Hydraulic Lime (NHL) and reinforced with an alkali resistant mesh. This intervention is especially suitable for floors or roof pitches

where a thin layer of clay bricks is resting on the wooden rafters.

Typical thickness of the mortar slab is 3-4 cm, connected to wooden structures with small diameter connectors to avoid buckling phenomena of the mortar slab layer when subject to compression (see Section 3).

Generally, minimum mechanical properties of mortar after 28 days from casting are: compressive characteristic strength: $f_{k,28g}=15$ MPa, Young modulus $E_{28}=16000$ MPa.

Main advantages of the use of NHL with respect to the standard concrete slab are: limited additional weight, in-plane stiffness of reinforced diaphragm more compatible with the building one, high compatibility of the intervention with existing structures and adequate reversibility.

This technique is spreading more and more thanks to the various benefits with respect to the more invasive RC slab. Clearly, this intervention does not provide any out-of-plane strengthening or stiffening, and therefore is not applicable when the wooden floor structure requires stiffening for vertical loadings. In this case, mortar slab reinforcement technique must be coupled with other interventions described below.

4.3. Reinforcement with additional layer of wood planks

Application of additional layers of planks or boards is a reinforcement techniques often adopted for floors and roofs pitches composed of beams, rafters and wooden planks. The additional layers are typically placed with an angle of 45° or 90° with respect to the original arrangement. A significant improvement of the in-plane strength and stiffness of the floors can be reached using single or double layer of planks (Valluzzi *et al.*, 2010).

With a single layer, some improvement of the out-of-plane features can be attained only if planks are aligned and overlapped to the main beams and rigidly connected with them. In this case a “T” wood-to-wood

composite cross-section is obtained, as shown in Figure 14.

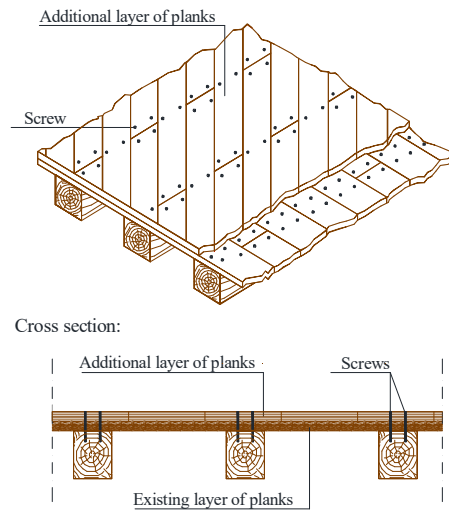

Figure 14. Floor reinforcement with additional layers of planks.

Many studies have been conducted on this strengthening technique, adopting also innovative screw fasteners (Giongo *et al.*, 2012). The structural design of this type of intervention can be carried out with reference to Eurocode 5. Clearly, connections between additional planks and existing wood structures play a crucial role for the structural efficiency of this type of reinforcement technique.

Double boards ensure high in-plane stiffness if correctly connected to the existing wood structures. Moreover, this intervention reduces excessive out-of-plane deformability of the deck allowing transverse load redistribution among different beams.

This intervention technique is generally adopted in old or degraded floors or roof pitches, and is a more compatible, lighter and reversible alternative with respect to the composite concrete slabs. Analogously to the concrete slab intervention, essential condition for the use of the technique is the possibility of dismantling or removing the flooring placed over the existing boards.

4.4. Reinforcement with multi-layered wood panels

An improvement of the reinforcement technique with additional wooden planks consists in the use of multi-layered wood panels (i.e. Plywood panels, Oriented Strand Board Panels, etc...) fastened to the existing wooden structures (Giuriani *et al.*, 2005). This solution has some advantages: speed of laying in work, reduced structural weight, both in-plane and out-of-plane improvement and finally adaptability for both floors and roofs. Generally, plywood panels (thickness $15 \div 30$ mm) are connected to each other by means of nailed steel plates and the whole pitch diaphragm is nailed to the perimeter steel chords and connected to the roof/floor rafters with screws or bolts (Figure 15).

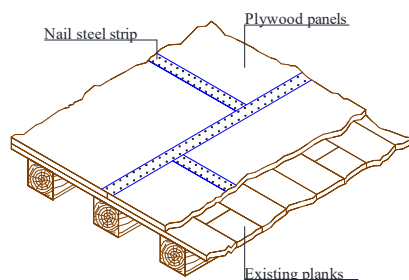

Figure 15. Floor reinforcement with multi-layered wood panels.

This technique offers both reversibility and limited additional weight and guarantees that the reinforcement does not cause any significant damage to the existing wood structure.

4.5. Reinforcement with additional steel elements

Reinforcement of wooden beams by means of steel profiles (i.e., HE, IPE or UPN profiles) connected at its intrados or extrados (Figure 16) is adopted if the existing main floor elements are no able to carry the operational loads. Adoption of steel element at the intrados (Figure 16a) is the easiest

intervention but quite invasive and sometimes unacceptable, especially in the presence of heritage constraints. Sometimes, steel profiles are placed on the sides of wooden beams (Figure 16b), being more acceptable and allowing to avoid clearance reduction of the lower floor. When possible, beam reinforcement at the extrados is preferred (Figure 16c), but requires super-removal of all or part of the existing superstructure (filling material, mortar under-paving, flooring, etc.). In this case, the steel profile is anchored to the wooden beam by metal connectors, realizing a composite steel-timber cross sections.

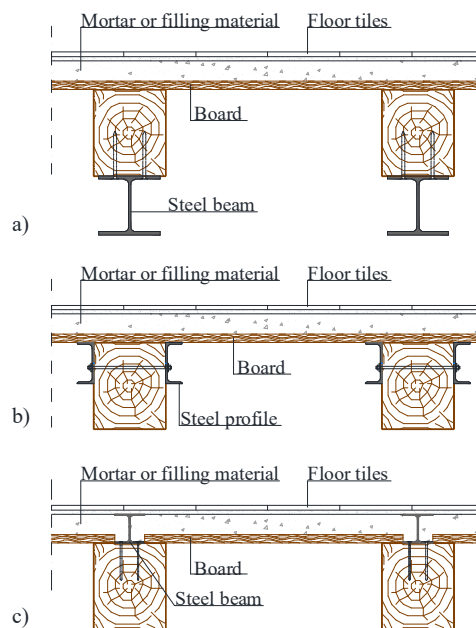

Figure 16. Steel profile reinforcements at a, b) intrados or c) extrados of wooden beams

An improvement of this strengthening technique was proposed in Gattesco *et al.* (2006), where the steel beam is replaced by metal steel plates connected to the beams through steel dowels (Figure 17a). In this case, connectors are forced with few hammer blows into bore holes, drilled in the timber member, and welded to the steel profile. The existing boarding partly contrasts the steel

plate against buckling.

This technique may be considered “dry” because does not use any gluing material to bond the dowels to wood or any other material to be cast in place. Being simple, cheap, fully reversible and very low invasive, these interventions allow to considerably improve the wooden slabs by minimizing the additional load on the existing structures.

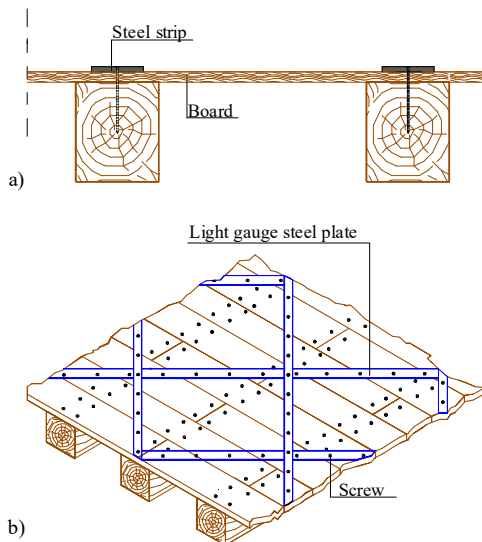

Figure 17. Schemes of wood-steel reinforcements suitable for (a) flexural – out-of-plane and (b) seismic – in-plane improvements.

If an improvement of the in-plane stiffness and strength of the wooden floor or roof pitches is required, diagonal steel bracing plates (Figure 17b) can be adopted (e.g., 80 mm wide, 2 mm thick), screwed at 45° on the existing wood planks. This intervention can also be combined with the above described reinforcement with additional boards.

4.6. Reinforcement with FRP

Fiber Reinforced Polymer (FRP) are innovative materials often adopted for

improving in- and out-of-plane behavior of existing wooden structures. Their main advantages are the very high strength/weight and stiffness/weight ratios, so that they are often preferred in rehabilitation interventions in existing buildings.

Criteria for proper use of composite materials for out-of-plane (i.e. flexural) improvement of wooden beams are reported in CNR guidelines DT 201 (2005). Similarly to the case of additional steel elements, FRP reinforcement can be placed on the extrados or intrados of existing timber structures (Figure 18a). FRP reinforcement can be constituted by pultruded shapes (typically glass fiber), bars or strips (carbon or glass fibers). Pultruded shapes require a fastening system to the wooden elements analogous to steel profiles, whereas bars and strips are bonded to wood by means of epoxy resin. In the last case, FRP elements can be glued on the external face of the wood beams or by realizing few centimeter deep sawings in the wooden beam. In the second case (analogous to the near surface mounting bar technique adopted for concrete elements), FRP-wood bonding is strongly improved, even if the intervention is of course more invasive, due to disalignment of wood fibers with respect to the sawing. An extensive test campaign on FRP flexural strengthening of wooden beams was performed by Borri *et al.* (2005).

FRP composites can be used also to improve the in-plane behavior of existing wooden floors and roof planks under earthquake actions. Similarly to the use of steel plates, a horizontal bracings system, realized by means of (carbon, glass or aramid) FRP fiber sheets bonded to the wooden surface, can be used to transfer the horizontal seismic action to the shear walls and to carry out-of-plane forces acting on walls. Of course, fiber sheets will carry the traction forces of the ideal truss system of resisting elements in the floor plane. Compression forces will be adsorbed by the existing wooden layer of planks that, if necessary, can be integrated by an additional layer.

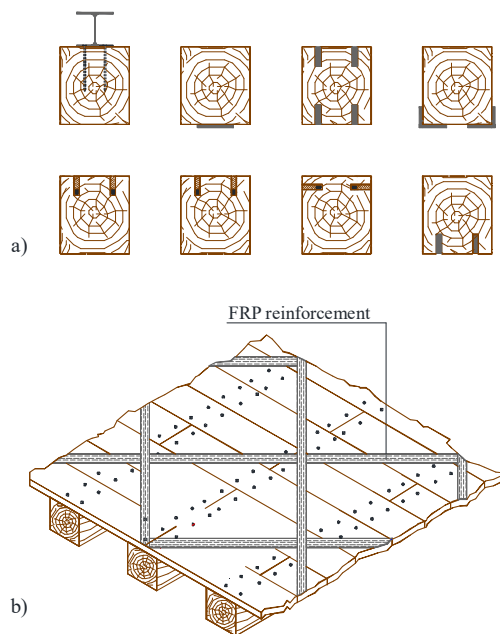

Figure 18. Schemes of typical (a) out-of-plane and (b) in-plane floor reinforcement with FRP

In the last years, some experimental researches were performed in order to evaluate the behavior of in-plane improvement interventions with FRP (Gubana, 2015). Experimental results highlighted the need to provide in-plane reinforcement with square mesh, but with sufficiently close spaced composite sheets (Figure 18b), in order to accompany the strength increase by an adequate stiffness increase (Corradi *et al.*, 2006; Piazza *et al.*, 2008).

Finally, it is worth remembering that durability is an issue that can limit the applicability of FRP strengthening system. This issue is treated by CNR standard DT 201 (2005) and in some research works (Corradi *et al.*, 2006; Gubana, 2015), especially as far as bonding between FRP and wood is concerned, in the presence of shrinkage and swelling phenomena of wood due to moisture changes.

4.7. Different in-plane floor strengthening techniques and effects on global building response

Strengthening of timber floors or roof pitches aims at increasing stiffness and strength of the diaphragm, but compatibility with the masonry WRS must be assured. If the quality of masonry is particularly poor, an excessive stiffness of the slab had proven to be dangerous for the masonry walls and the overall building behavior.

The stiffening intervention modifies the force distributions among the WRS. As reported in Figure 19, stiff diaphragms induce a hyperstatic force distribution between the shear walls, while deformable diaphragms realize an isostatic force pattern. The difference can be even more significant in the presence of an irregular distribution of the masonry walls, with possible torsional effects on the building dynamic behavior in the case of stiff diaphragms.

The relation between diaphragm stiffness and force redistribution among the wall is of crucial importance in the design of retrofitting interventions.

Research is now focused particularly on how to increase the global building seismic response and improve the compatibility of the two systems (diaphragms and WRS), without introducing irregularities and excessive strength and stiffness that may induce local failures or damages. Different solutions may fit different situations.

For a better understanding of the in-plane behavior of flexible timber diaphragms, several experimental tests and numerical studies were undertaken by various researchers.

Many studies and guidelines concerned the interaction between floor diaphragm and shear walls in modern timber frame structures. Few studies only concerned the improving technique typically adopted for traditional timber floor (Baldessari *et al.*, 2009; Valluzzi *et al.*, 2010). Experimental in-plane testing on floor slabs were

performed, both in reduced as well as in full scale, and numerical models were calibrated for slabs with different reinforcement. Even though these researches were based on tests conducted on newly built specimens, which do not permit to take into account the mechanical properties of actual ancient diaphragms subjected to decades of service life, some qualitative indications can be drawn.

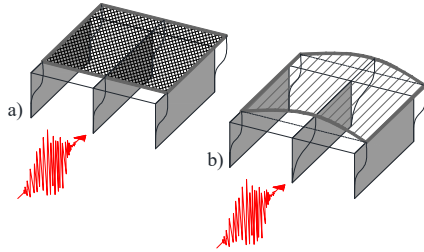

Figure 19. (a) Hyperstatic and (b) isostatic force redistribution among WRS, depending on the diaphragm stiffness

The most comprehensive research activities were performed by Baldessari *et al.* (2009). In this research, six different floor timber diaphragms were characterized by means of experimental cyclic tests on 5m×4m specimen: (1) unreinforced floor with single nailed boards, (2) double boards reinforcement, (3) steel plates reinforcement, (4) FRP strip reinforcement, (5) plywood panel reinforcement, (6) concrete slab reinforcement.

Valluzzi *et al.*, (2010) tested different floor diaphragms improved with double boards, under monotonical loading, and compared the results with respect to unreinforced floors. Specimen dimensions were 2.2m×2.2m.

The results of the two researches are not directly comparable due to the differences in the adopted test setup and material properties, and well as for the size effect playing a relevant role on the global response. However, some common findings were obtained concerning the design approach and the relative stiffening level

reached with different improvement interventions.

From the modelling point of view, as far as the in-plane mechanical behavior of the floor is concerned, it must be underlined that very often the concepts of in-plane stiffness and strength are confused. It is unanimously agreed that, without a sufficient stiffness of the floors in their planes, no diaphragm behavior can be assured and the effects of the earthquake can be not only dangerous for the building, but also in some way unpredictable with a numerical model. Moreover, controlling the in-plane stiffness of the diaphragm by adopting a specific strengthening intervention, the overall deformation of the building can be limited. If lateral displacements of walls are maintained within a targeted admissible level, out-of-plane overturning mechanisms of the walls can be avoided (Brignola *et al.*, 2008).

The estimate of the in-plane floor stiffness is then a fundamental task. Of course, strengthening by realization of a RC slab could ensure an almost infinitely stiffness diaphragm. However, results from Baldessari *et al.* (2009) showed that: (1) the in-plane stiffness achieved by reinforcing the existing floor with additional multi-layered wood panels or by realizing a steel or FRP lattice structure is comparable with that attainable by RC reinforcement (the maximum difference being about 15%); (2) stiffness of the diaphragm strengthened by single or double boards is significantly smaller (about 50% lower) compared to the concrete slab reinforcement, but about 30 times greater than that of the unreinforced diaphragms.

Another relevant issue concerns the correlation between the in-plane stiffness of the diaphragm and its orthotropic behavior, due to the wood structure constituted by planks, purlins and beams. In the case of unreinforced diaphragms, the in-plane stiffness is different in the two directions, being minimum along the beam axis because it involves only the plank stiffness, and

maximum perpendicular to beam axis, including the contribution of both plank stiffness and flexural stiffness of the main beams in the transverse direction. Of course, all the improvement interventions, increasing the slab stiffness, reduce the influence of beam direction and, therefore, the orthotropic behavior of the diaphragms.

The stiffness of the diaphragm will then have a significant influence on the distribution of forces also at the masonry wall/diaphragm connection (see Figure 19 as an example), but very few studies are available on the subject.

5. Masonry-floor and masonry-roof connections

The seismic response of ancient unreinforced masonry (URM) buildings is strongly affected by the quality of the connections between the different building structural components. Connections between wooden floor and masonry walls are typically absent, or certainly inadequate to transmit the shear forces required to assure the ideal box-like behavior of the building.

In the past, concrete curbs were realized in the wall thickness by partially demolishing the masonry wall, an intervention now considered too invasive and often negative, because a localized weakness in the masonry wall is introduced due to the partial demolition at the floor level. A less invasive but still not suggested intervention consider the realization of dovetail reinforced concrete joints of the floor in the wall thickness.

Nowadays, wall-to-diaphragm connections are often realized by means of steel profiles with regularly spaced anchors chemically or mechanically connected to the masonry wall (Figure 20). Closely spaced connectors along the diaphragm edge guarantee a nearly uniform transmission of shear forces to lateral walls, without damaging them. Anchorages based on adhesives (e.g., epoxy resin or cement grout) provide a very

efficient connection, but may have some inconveniences, particularly in terms of restoration issues. On the other hand, dry installation of dowels is fast and reversible, with shear capacity similar to that obtained by grout injected connections (Felicetti *et al.*, 1997), but significantly lower pull-out strength (Gattesco and Del Piccolo, 1998; Giuriani *et al.*, 1993).

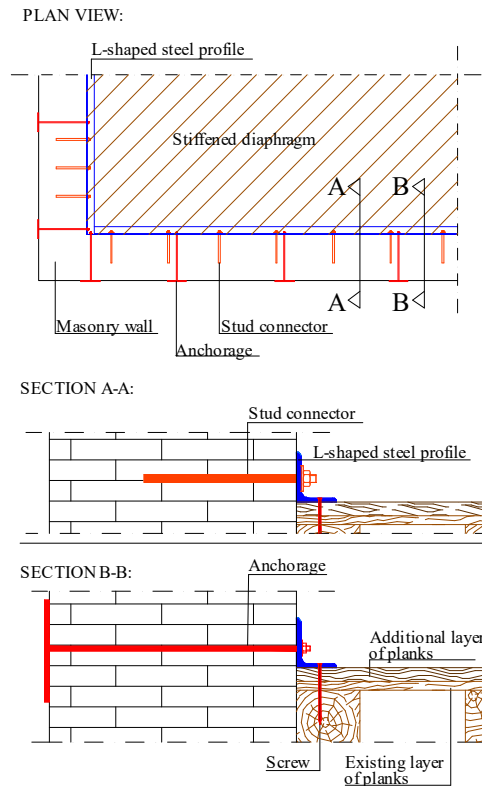

Figure 20. Examples of perimetral steel profiles with stud or anchorage connections

Nevertheless, even if this technique is now widespread, few information are available on capacity of the anchorages to be used in design. When possible, it could be deduced from in situ tests to be conducted on URM walls in the same building, following the test setup illustrated in Giongo *et al.* (2014). Few analytical formulations are available in the literature, as the shear strength estimate of connections by Gattesco and Del Piccolo

(1998) and Giongo *et al.* (2014). Nevertheless, the correct evaluation of the shear transferring capacity of connections is still an open problem, and it may depend on many parameters, such as the anchor rod diameter, the embedment depth, the boundary conditions, the washer size and the axial pre-load of the anchor.

6. Case study

The application of some of described retrofitting solutions for seismic strengthening of an old barn masonry structure is detailed in this section. The retrofit project involved repair and local strengthening of structural elements damaged by the Emilia earthquake (Italy) in May 2012, as well as the seismic improvement of the building, for a seismic action which by regulation must be at least 60% of that prescribed for a new construction. The illustration here is focused on the timber roof strengthening, including its proper connections with masonry walls in order to ensure a box-like behavior of the building against seismic forces.

6.1. Building description

The barn, located in San Benedetto Po (MN), Italy and belonging to the historic court of “Bugno Martino” (Figure 21), was built in XVIII century. It has a rectangular plan with dimensions 25.69× 59.78 m. The bearing structure is constituted of walls and pillars in solid bricks, timber gable roof and masonry strip foundations. Typical wall thickness is 50 cm, and pillar section is 90×60 cm.

The building has three longitudinal aisles, with two levels for the central one and one for the lateral aisles (Figure 22). The first floor of the central aisle has 17 masonry vaults supported by two rows of round masonry columns.

The roof structure is constituted of simple timber trusses in the central aisle, supporting a secondary framework of round rafters, 24

cm diameter. The secondary framework is a grid of wooden joists supporting roof tiles (Figure 24). The secondary timber framework of lateral aisles is analogous, but the principal structure is constituted of wood poles, 30 cm of diameter, with diagonal struts acting as an intermediate supports (Figure 25a). The wooden roof is very deformable and unable to act as a diaphragm, as required to assure a box-like behavior to the masonry structure (Figure 26).



Figure 21. Bugno Martino (MN) old barn: (a) north elevation, (b) west elevation

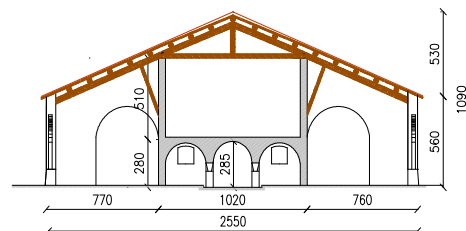

Figure 22. Typical cross-section of the barn with indication of the main wooden structure

6.2. Structural vulnerability

6.2.1. Earthquake damages

After the 2012 earthquake, the building revealed a widespread cracking on masonry walls and pillars, in particular at the supports of wood beams and trusses. Moreover, some lateral wall portions and pillars exhibited

considerable out-of-plane residual displacements. Consequently, many timber beams, belonging to trusses and secondary framework, as well as the diagonal struts of the lateral aisles (Figure 27), showed evident slippage from the masonry supports.

a)

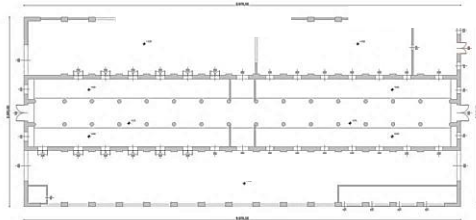

b)

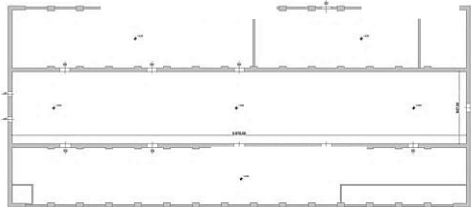

c)

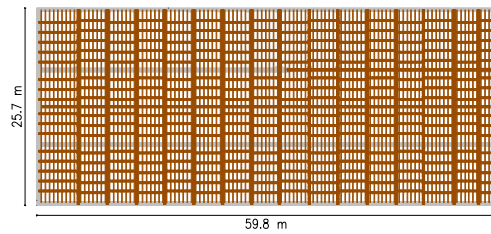

Figure 23. a) ground floor plan, b) first floor plan, c) arrangement of timber roof beams and rafters



Figure 24. First floor of the central aisle



a)



b)

Figure 25. Lateral aisles: a) masonry wall, b) the wooden roof structure.



Figure 26. Flexible timber roof of the barn.

It was evident that damages were mainly due to the significant slenderness of masonry walls and pillars, as well as to the inefficiency of the wooden roof to prevent relative movements due to its high deformability.

6.2.2. Seismic vulnerability and structural modelling

In order to estimate the seismic vulnerability of the existing building, to calculate seismic actions and to design the retrofit interventions, FEM modelling of the barn structure was performed using Sismicad 12.5 software (see Figure 28). Isotropic shell elements for masonry walls and isotropic beam elements for timber beams were adopted. The pitch rafters-to-wall, as well the rafters-to-rafter supports along the roof ridge, were modeled as hinges.



a)



b)



c)

Figure 27. a,b) Relative displacements of diagonal struts of the lateral aisles with respect to masonry support; c) overturning of a masonry wall portion.

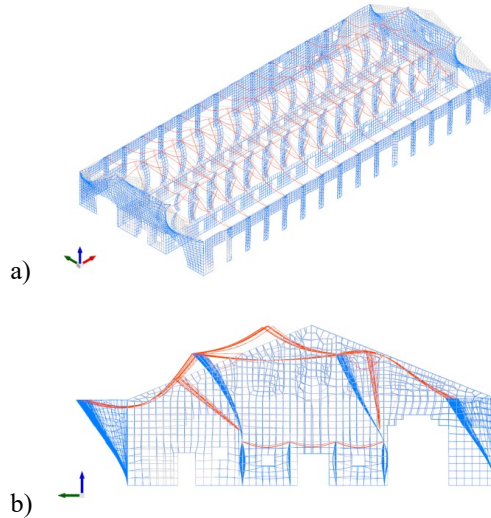

Figure 28. FEM modelling of the barn before retrofit - Displacements for earthquake action in the transverse direction: a) global view and b) lateral displacements in a transverse section far from the two masonry gable walls.

The seismic vulnerability assessment showed a very low safety index, $\alpha = 0.205$, where α is the ratio between capacity and seismic demand in terms of peak ground accelerations, i.e., $\alpha = PGA/PGA_{RIF}$.

FEM analysis confirmed that the main vulnerabilities of the structure are directly linked with the excessive deformability of the roof structure. In the case of accelerations in the transverse direction, the roof is not able to act as a diaphragm, to transfer the seismic action to the transverse gable walls and to prevent overturning of the slender longitudinal walls.

6.3. Interventions for seismic improvement

The principal interventions for seismic retrofit were aimed at assuring the adequate stiffness to the wooden roof to act as a diaphragm.

Figure 28b and Figure 29 show the transverse displacements in a section of the

building far from the transverse gable masonry walls. Comparison confirms that the roof behaves as a diaphragm after the intervention, strongly reducing the lateral deflection of longitudinal walls.

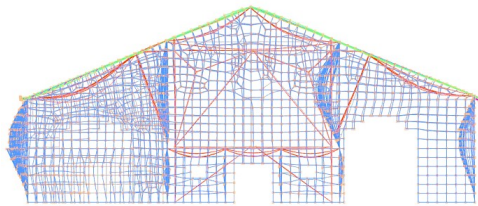

Figure 29. FEM modelling of the barn after retrofit - lateral displacements in a transverse section far from the two masonry gable walls.

Interventions must also include some local strengthening on degraded wood elements and cracked masonry structures, in particular at the level of timber beam supports.

6.3.1. Global interventions on timber roof

The most important interventions on the timber roof were the following (see Figure 30):

- 1) The flexible roof was retrofitted with 27 mm thick multi-layered wood panels, placed on the existing grid of wooden joists. The construction details are reported in Figure 31. Wood panels, with 2.4×1.2 m dimensions, are connected to each other through steel plates 2×80 mm connected through steel nails ($\phi 4 @ 80$ mm). The multi-layered wood panels are connected to the extrados of the roof rafters and beams, by means of 8-10 mm screws at 600 mm spacing, approximately. Moreover, the secondary frameworks were connected to the main beams with the same kind of screws.

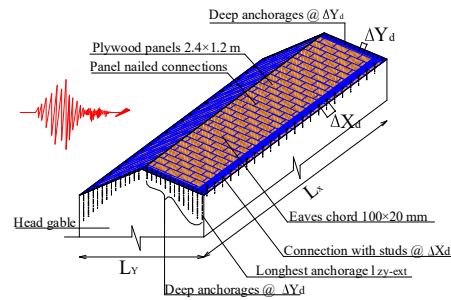
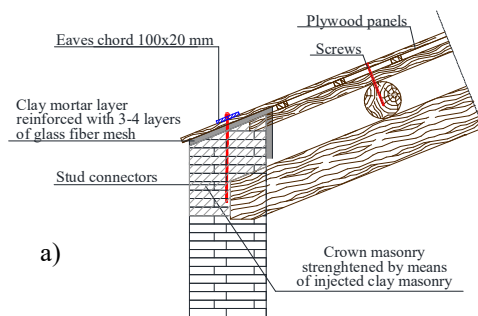

Figure 30. Reinforcement of the barn roof with multi-layered wood panels. Ora Lx sono grandi

- 2) Perimeter steel plates (20×100 mm) were placed on the wood panels and well connected with the masonry walls, through stud connectors (16 mm diameter) with deep anchorage. The eaves chords are then part of the diaphragm resisting systems and suitable to withstand the axial forces induced in the pitch panels by the seismic action. Then, the deep anchorages avoid the roof uplift and the stud connections guarantee shear transferring between the wood panels and the masonry top.
- 3) Along the wall crown, clay injections are performed for consolidation, and a clay mortar layer, reinforced with 3-4 layers of glass fiber mesh, is realized.



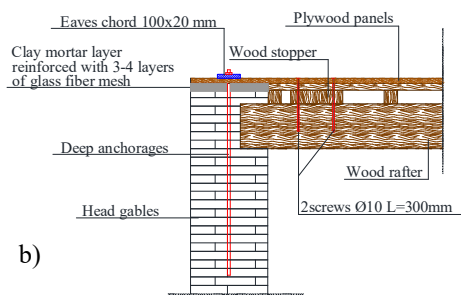

Figure 31. Wood diaphragm – masonry connection: a) transverse section on longitudinal masonry wall, b) transverse section on head gables

The proposed strengthening technique is reversible and of minimum impact on the building integrity, following the intervention criteria indicated by the Commission for the Architectural and Landscape Heritage (DPCM 26.02.2011).

6.3.2. Local interventions on timber beams

Ancient wooden elements may present an insufficient resisting section, often due to the effect of wood deterioration. Damage is often present at the beam extremities, where the shear force is maximum and the beam, constrained in the masonry wall and suffering limited air circulation, is subject to a moisture contents above 20% and, as a consequence, is vulnerable to biotic attacks. Some damages observed in the case study are reported in Figure 32.

The damaged parts must be eliminated and replaced with new material, which can be wood or other materials such as fiber glass composites, provided the collaboration between the new and the original part of the beam is ensured. Other possible solutions consist in creating a new support for the beams, with the insertion of shelves (wood, stones, iron) under the beams. These types of interventions, very common in the past, are nowadays almost unchanged except for the use of new materials.



Figure 32. Local damages and deterioration on supports of timber elements.

Some examples of typical intervention methods are reported in Figure 33: (a) use of a wooden prosthesis connected with rebars to the existing wood beam; (b), c)

reinforcement with steel or wooden shelf; (d) wood substitution by plating with other wooden elements; (e, f) external reinforcement with wooden lateral boards or steel plates. Applicability of these methods depends on the peculiarity and architectural features of the historic building. However, the described interventions are scarcely reversible and may modify significantly the interaction between the wooden structure and the masonry walls. In the present case study, the solutions corresponding to letters a) and f) in Figure 34 were adopted in the preliminary design. Nevertheless, after a careful inspection, many elements showed a deep biotic attack and, consequently, replacement of many supporting beams and purlins was necessary. Connection of wood structural elements and joints is another important issue. Ancient floor and roof structures are generally realized by assembling wooden members by means of carpentry joints fastened with metal nails, bolts and steel plates. The role of fastening devices is crucial for the structural stability of the wooden assemblies. However, during the years, such fastening systems can deteriorate due to wood damage or steel corrosion, and structural efficiency of joints or wood assemblies can be fully compromised (Figure 34 a, b). Sometimes, connections between principal rafters and secondary beams are even fully absent (Figure 34c).

Experimental tests (Tomasi *et al.*, 2007) highlighted that wood roof trusses can be subject to brittle failure of wooden joints causing the full collapse of the structure, especially during seismic events. Very restrictive checks of these nodes are then prescribed by codes (D.M. 14.01.2008).

In case of an earthquake, the effects of inertial forces on the wooden structures and the relative displacement of the masonry walls can require the transmission of significant forces between wood elements and at the wood beam – masonry support level. Moreover, joints of the wooden truss behave as hinges with a low rotational

restraint. The resulting structural scheme is effective for loads in the truss plane, but very unstable for accidental lateral forces or horizontal forces due to an earthquake, with possible very dramatic collapses (Parisi e Piazza, 2015).

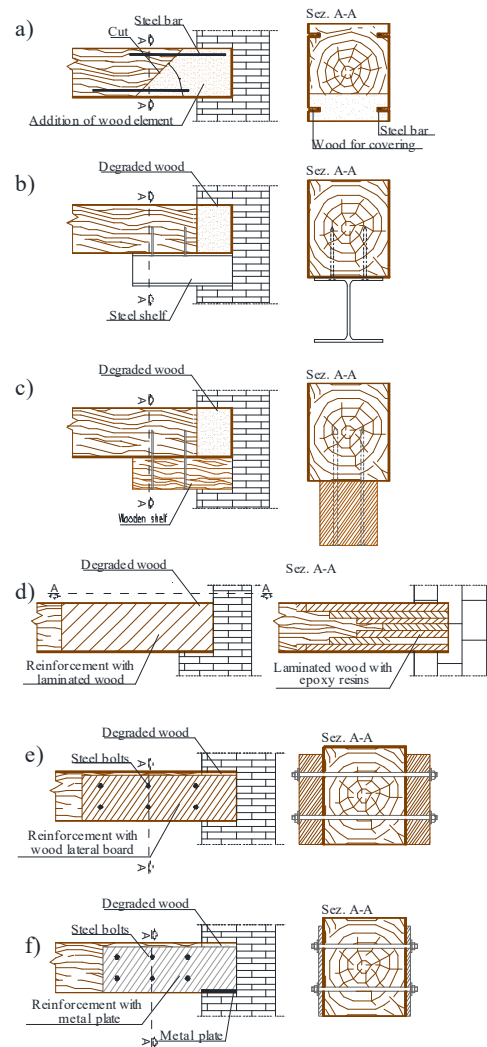

Figure 33. Typical interventions in the case of damaged extremities of timber beams

The load bearing capacity of the joints of the wooden roof truss can be restored by means of additional connectors such as steel bars or plates. In the present case, external steel ties were used for the main joints (Figure 35a), in

order to avoid to realize holes in the existing beams (Figure 35b), which can cause the onset of new biotic degradation in the future.

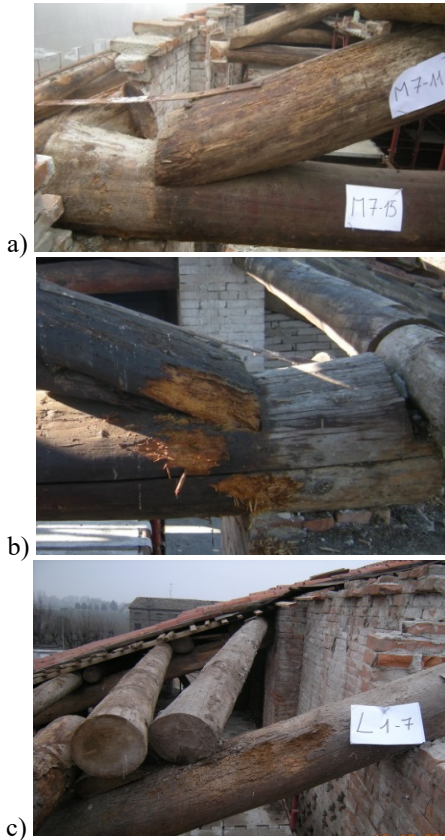

Figure 34. a, b) Damages in joints of the wooden truss; c) absence of connectors between wood rafters and secondary beams

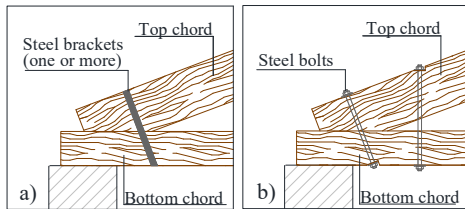

Figure 35. a), b) strengthening intervention of joints between wooden beams of the roof truss

The load bearing capacity of the joints of the wooden roof truss can be restored by means of additional connectors such as steel bars or

plates. In the present case, external steel ties were used for the main joints (Figure 35a), in order to avoid to realize holes in the existing beams (Figure 35b), which can cause the onset of new biotic degradation in the future.

6.4. Design of the wooden roof as a part of an earthquake-resisting structure

In this section, the preliminary design of the wooden roof as a part of an earthquake-resisting structure is described. The design, following the criteria illustrated in Section 3.3, considers the realization of a diaphragm at the roof level. For an earthquake action in the transverse direction (the most critical case), eaves chords and pitch panels withstand the global bending moment and shear on the roof plane induced by the seismic action (Figure 36). The pitch panels transfer the seismic action to the two head gable walls at the extremities of the barn, and then the action is transferred to the foundations.

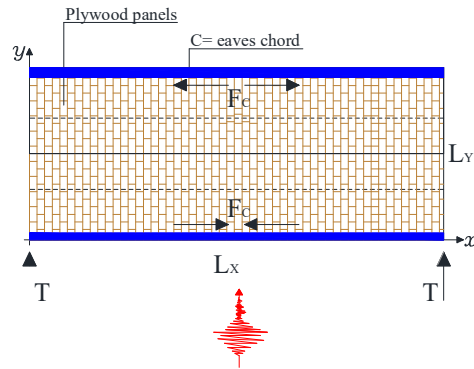

Figure 36. Roof subject to earthquake action in the transverse direction.

The geometrical data of the structure are the following (see Figure 37 and Figure 23):

$$L_x = 59.8 \text{ m}; L_y = 25.7 \text{ m}; L_f = 14 \text{ m}; \alpha = 22^\circ$$

$$h_1 = 5.3 \text{ m}; h_2 = 5.5 \text{ m}; h_3 = 5.1 \text{ m}; h_4 = 2.8 \text{ m}$$

Moreover, the thickness of the main walls is $s_m = 48 \text{ cm}$, and the weight per unit of volume of the masonry is assumed $\gamma_m = 18 \text{ kN/m}^3$.

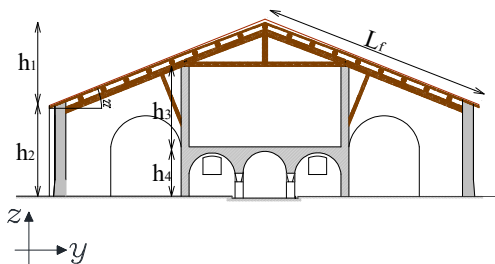

Figure 37. Transverse section of the barn structure with identification of main dimensions

Considering the earthquake design response spectrum for the site and performing a dynamic modal analysis of the structure, the seismic action, in terms of total shear at the building base, can be estimated as 10% of the vertical loads.

From load analysis, permanent roof weight is $g_1 = 1.25 \text{ kN/m}^2$. The total weight of masonry walls is $G_2=3447.87 \text{ kN}$, computed as half of the mass corresponding to the the upper interstory height, i.e., $h_3/2$ for the central part and $h_2/2$ for the lateral walls (see Figure 37).

The horizontal loads for unit of length corresponding to roof and masonry wall contributions are, respectively:

$$p_1 = (g_1 \times L_f \times 2) \times 10\% = 3.5 \text{ kN/m}$$

$$p_2 = (G_2/L_x) \times 10\% = 5.76 \text{ kN/m}$$

where L_f is the pitch width.

The horizontal seismic action, per unit of length of the barn, acting in Y - (transverse) direction (see Figure 10) is then equal to:

$$f_y = p_1 + p_2 = 3.5 + 5.76 = 9.26 \text{ kN/m}$$

The maximum bending moment M and the maximum shear T acting in the horizontal plane of the roof are then equal to:

$$M = f_y \times L_x^2 / 8 = 9.26 \times 59.8^2 / 8 = 4139.3 \text{ kNm}$$

$$T = f_y \times L_x / 2 = 276.9 \text{ kN}$$

The axial force F_c on the eaves chord is finally obtained dividing the maximum bending moment M by L_y :

$$F_c = M/L_y = 4139.9/25.7 = 161.1 \text{ kN}$$

The eaves chord cross-section area A_c was chosen by adopting a conservative value for the steel design strength of 100 MPa, in order to ensure its elastic behaviour and deformation compatibility with the masonry crown. A steel plate with $100 \times 20 \text{ mm}$ cross-section was then adopted (Figure 30 and Figure 38).

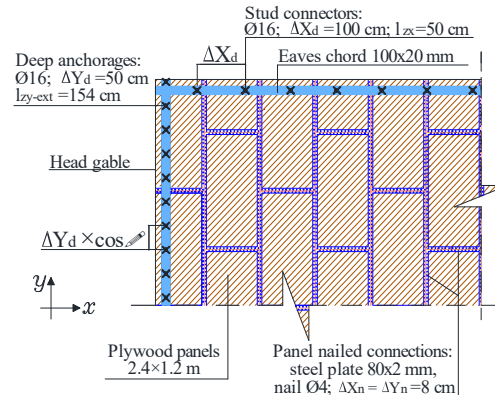

Figure 38. Reinforcement of the barn roof with multi-layered wood panels - Plan view of a portion of the roof

Plywood panels constituting the roof diaphragm are connected to each other through nailed steel flanges; the same nailed connection was used to fix the eaves chords to the plywood panels. To evaluate the maximum allowable nail spacing $\Delta Y_n = \Delta X_n$ along steel flanges, 4 mm diameter high strength steel nails were considered, whose experimental ultimate strength is about $V_{nu} = 3 \text{ kN}$, and design strength is assumed as $V_{nd} = 1 \text{ kN}$ (Giuriani *et al.*, 2008). The distributed shear along the diaphragm cross-section is $q = T/L_y = 10.77 \text{ kN/m}$, then indicating a maximum nail spacing:

$$\Delta Y_n = V_{nd}/q = 1/10.77 = 9.2 \text{ cm}$$

(8 cm was adopted)

To avoid out-of-plane buckling of wood panels, additional screws are prescribed, to join directly the panels to the roof elements (rafters, beams), i.e., 10 mm screws at approximately 60 cm spacing.

The dowels connecting the pitch diaphragm

to the transverse masonry gables are subjected to the same distributed shear q . The maximum dowel spacing is then equal to:

$$\Delta Y_d = V_{dn} / q = 6 / 10.77 = 56 \text{ cm}$$

(50 cm was adopted)

being $V_{dn} = 6$ kN the plywood panel to masonry wall connection design resistance, corresponding to $1/2$ of the smallest value recorded in experimental tests on 16 mm diameter steel studs (Gattesco and Del Piccolo, 1998, Giuriani, 2004)

With reference to Figure 10 and Figure 30, in order to avoid the uplift of the roof, the minimum anchoring depth of the longest vertical anchorages placed at the extremities of the head gables, l_{zy-ext} , is obtained from the following relations:

$$f_u = m/W = 6m/L_y^2 = 6 \cdot T \cdot h_1 / L_y^2 = 13.33 \text{ kN/m}$$

$$l_{zy-ext} \times b \times \gamma_m \times \Delta Y_d = f_u \times \Delta Y_d$$

$$l_{zy-ext} = f_u / (b \times \gamma_m) = 13.33 / (0.48 \times 18) = 154 \text{ cm}$$

The length l_{zy-ext} can be reduced if the effective confining vertical load, provided by the the dead loads of the roof W_g belonging to the head gable, is taken into account.

$$l_{zy-ext} = (f_u - W_g) / (b \times \gamma_m)$$

The minimum length of the deep anchorages decreases from the external side to the peak of the head gables, up to $l_{zy} = 50$ cm.

On the contrary, along the lateral walls no anchorages are needed because the box-structure uplift is inhibited by the dead loads of the roof W_g belonging to the longitudinal lateral walls. The dead load W_g was prudentially reduced by 30%, to consider possible vertical load reduction induced by the seismic acceleration vertical component.

In order to allow shear transferring, wall-to-pitch diaphragm dowel connections are required. In the design, 16 mm diameter studs were adopted, with ΔX_d spacing, calculated considering a reduced value of the stud strength ($V_{dn} = 3$ kN) to account for the the reduced out-of-plane shear resistance of the top wall. Hence:

$$\Delta X_d = V_{dn} / (p_2/2) = 3 / 0.0288 = 104 \text{ cm}$$

where $p_2/2$ is the transverse shear force transferred by the lateral walls to the box-structure.

The length l_{zx} of stud connectors must be 20 times diameter at least, hence $l_{zx} > 20 \times 1.6 = 32$ cm (50 cm was adopted).

Finally, the displacements before and after the structural interventions, obtained from FEM modelling, are reported. The current code (D.M. 14.01.2008) requires the maximum interstory drift d_e , evaluated for the damage limit state (DLS), be less than 0.003. For the model before interventions, maximum displacement s , for DLS load condition, is equal to 4.15 cm for a node placed at the top of a wall 5.89 m height (Node 7859). Consequently, maximum drift d_e is greater than the admissible:

$$d_e = s/h = 4.15/589 = 0.007 > 0.003$$

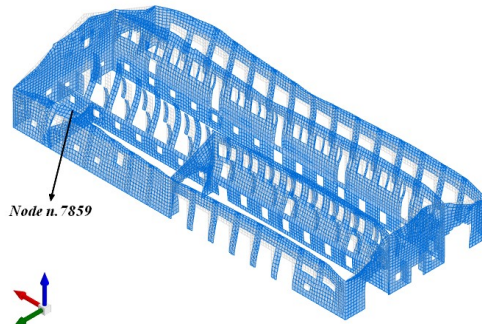

Figure 39. Maximum displacements in DLS load condition for the FEM model before the interventions

After structural interventions, the maximum interstory drift is equal to 0.00125, that is smaller than the limit value of 0.003.

7. Conclusions

In the paper, traditional and innovative solutions for the use of wood based techniques in seismic retrofitting design of masonry buildings are presented and discussed. Wooden roof or floors can be strengthened in order to act as horizontal

diaphragms so improving the box-like structural behavior of the building when subject to earthquake actions. The objective is to realize a structure where the wooden roof is capable of transmitting the inertia forces to the masonry walls in the direction of the action, and to avoid overturning and collapse of the walls in the transverse direction. Strengthening of the wooden elements can be done with retrofitting techniques with different degrees of effectiveness and invasiveness. Strength and stiffness of the diaphragms, as well as the connection elements with the masonry walls, are the key elements of the retrofit design, and basic design criteria are illustrated. Architectural preservation constraints and quality of the masonries can be two additional elements for selection of different retrofit solutions. The case study presented at the end of the paper shows how the use of

modern solutions in the realization of the wooden roof and connections with the masonry walls can improve the safety of the building by strongly reducing displacements and the possibility of overturning failures of slender masonry elements.

Acknowledgment: The present investigation was developed within the activities of the (Italian) University Network of Seismic Engineering Laboratories–Reluis in the research program funded by the (Italian) National Civil Protection– Progetto Esecutivo 2015 – Research Line “Wood Structures”. Technical outcomes are promoted in synergy with “Adria-Hub” collaborative project inside the IPA Adriatic CBC Program (details in Savoia *et al.*, 2016). The financial support of Fondazione Cassa di Risparmio di Imola is gratefully acknowledged.

References:

- Baldessari, C., Piazza, M. & Tomasi, R. (2009). *The refurbishment of timber floors: characterization of the in-plane behaviour*. PROHITECH Int. Conf., Taylor & Francis, London, 255–260.
- Borri, A., Corradi, M. & Grazini, A. (2005). A method for flexural reinforcement of old wood beams with CFRP materials. *Composites: Part B*, 36, 143–153.
- Branco, M. & Guerreiro, L.M. (2011). Seismic rehabilitation of historical masonry buildings. *Engineering Structures*, 33, 1626–1634.
- Brignola, A., Pampanin, S. & Podestà, S. (2009). Evaluation and control of the in-plane stiffness of timber floors for the performance-based retrofit of URM buildings. *Bulletin of the New Zealand Society for Earthquake Engineering*, 42(3),
- CNR DT 201:2005. (2005). *Studi Preliminari finalizzati alla redazione di istruzioni per interventi di consolidamento statico di strutture lignee mediante l'utilizzo di compositi fibrorinforzati* (in Italian).
- Corradi, M., Speranzini, E., Borri A. & Vignoli, A. (2006). In-plane shear reinforcement of wood beam floors with FRP. *Composites Part B*, 37, 310–319.
- Crocetti, R., Sartori, T, Tomasi R, & Cabo, J.L.F. (2013). *An innovative prefabricated timber-concrete composite system*. RILEM 2013: Materials and Joints in Timber Structures - Recent Advancement of Technology Stuttgart, Germany: Springer, 2014. Proceedings of RILEM 2013, Stuttgart, 2013.
- D.M. 14.01.2008 (2008). *Nuove norme tecniche per le costruzioni*, G.U. 4.02.2008, n.29, Ministero delle Infrastrutture, dell'Interno e Dipartimento Protezione Civile, Roma, 2008 (in Italian).

- DPCM 26.02.2011 (2011). *Linee Guida per la valutazione e riduzione del rischio sismico del patrimonio culturale con riferimento alle norme tecniche per le costruzioni*, (Guidelines for risk evaluation and reduction of the cultural heritage, by the Ministry of Cultural Heritage, MiBACT), G.U. 26.02.2011 n.47, Roma, 2011 (in Italian).
- EN 1995-1 (2009). *Eurocode 5: Design of timber structures. Part 1-1: General rules and rules for the buildings*, CEN, European Committee for Standardization, Brussels, Belgium.
- EN 1998-1 (2013). *Eurocode 8: Design of structures for earthquake resistance. Part 1: General rules, seismic actions and rules for buildings*, CEN, European Committee for Standardization, Brussels, Belgium.
- Felicetti, R., Gattesco, N., & Giuriani, E. (1997). Local phenomena around a steel dowel embedded in a stone masonry wall. *Materials and Structures/Matériaux et Constructions*. 30, 238-246.
- Gattesco, N. & Del Piccolo, M. (1998). Shear transfer between concrete members and stone masonry walls through driven dowels. *International Journal of Earthquake Engineering and Engineering Seismology*. XII(1).
- Gattesco, N. & Macorini, L. (2006). *Strengthening and stiffening ancient wooden floors with flat steel profiles*. Structural Analysis of Historical Constructions, New Delhi.
- Gattesco, N. (2001). *Experimental study on different dowel techniques for shear transfer in wood-concrete composite beams*. Creative Systems in Structural and Construction Engineering, Shing (ed.), Balkema, Rotterdam, 487-492.
- Gelfi, P. & Giuriani, E. (1999). *Behaviour of stud connectors in wood-concrete composite beams*. Structural Studies, Repair and Maintenance of Historical Buildings VI: Proceedings of the 6th International Conference (Stremah 99), Dresden, Germany, Wit Press, 565-578.
- Giongo, I., Dizhur, D., Tomasi, R. & Ingham, J.M. (2015). Field testing of flexible timber diaphragms in an existing vintage URM building. *ASCE Journal of Structural Engineering*, 141(1) Special Issue: Field Testing of Bridges and Buildings, art no. D4014009.
- Giongo, I., Dizhur, D., Tomasi, R., & Ingham, J. (2014). *In-situ testing of wall-to-diaphragm shear transferring connections in an existing clay brick URM building*. 9th International Masonry Conference in Guimarães.
- Giongo, I., Piazza M. & Tomasi, R. (2012). *Cambering of timber composite beams by means of screw fasteners*. Proceedings of the International Conference on Structural Analysis of Historical Constructions SAHC 2012, Wrocław, Poland, 15-17 October, 2012.
- Giuriani, E. & Marini, A. (2008). Wooden roof box structure for the antiseismic strengthening of historic buildings. *International Journal of Architectural Heritage*, 2, 226-246.
- Giuriani, E. (2004). L'organizzazione degli impalcati per gli edifici storici. *L'Edilizia, Speciale Legno Strutturale*, 134, 30-43 (in Italian).
- Giuriani, E. (2006). *Rinforzo di solai in legno mediante soletta collaborante di calcestruzzo*, in L. Dezi and N. Gattesco (eds) *Strutture Composte – Nuove costruzioni, recupero, ponti*, International Centre for Mechanical Sciences, CISM, Udine, Italy, ISBN 88-85137-20-2, 2006, 311-322 (in Italian).
- Giuriani, E., Gattesco, N. & Del Piccolo, M. (1993). Experimental tests on the shear behaviour of dowels connecting concrete slabs to stone masonry walls. *Materials and Structures/Matériaux et Constructions*, 26, 293-301.

- Giuriani, E., Marini, A. & Plizzari, G. (2005). Experimental behaviour of stud connected wooden floors undergoing seismic action. *Restoration of Buildings and Monuments*, 11(1), 3-24.
- Gubana, A. (2015). State-of-the-art report on high reversible timber to timber strengthening interventions on wooden floors, *Construction and Building Materials*, 97, 25–33.
- Parisi, M.A. & Piazza, M. (2015). Seismic strengthening and seismic improvement of timber structures. *Construction and Building Materials*, 97, 55-66.
- Piazza, M. & Turrini, G. (1983). *Una tecnica di recupero statico dei solai in legno*. Recuperare, 5, 6, 7, Milano (in italian).
- Piazza, M., Baldessari, C. & Tomasi R. (2008). *The role of in-plane floor stiffness in the seismic behaviour of traditional buildings*. 14th World Conference on Earthquake Engineering, October 12-17, 2008, Beijing, China.
- Ronca, P., Gelfi, P. & Giuriani, E. (1991). *The behaviour of a wood-concrete composite beam under cyclic and long term loads*, Structural Repair and Maintenance of Historical Buildings, 2nd International Conference STREMAH 91, Seville, Spain, 1, 263-275.
- Savoia, M., Stefanovic, M., Fragassa, C. (2016). Merging Technical Competences and Human Resources with the Aim at Contributing to Transform the Adriatic Area in Stable Hub for a Sustainable Technological Development. *International Journal of Quality Research*, 10(1), 1-16.
- Tomasi, R., Piazza, M., Parisi, M.A., & Branco, J. (2007). *Analisi sperimentale su collegamenti tradizionali e rinforzati nelle capriate lignee*. ANIDIS 2007 - XII Convegno L'ingegneria sismica in Italia, Pisa, 10 -14 (in italian).
- Tomazevic, M., Velechovsky, T. & Weiss, P. (1992). *The effect of interventions in the floor structural system on the seismic resistance of historic stonemasonry buildings—an experimental study*. Proceedings of the 10th World Conference on Earthquake Engineering. 1–10, 5321–26.
- UNI standard 11119:2004 (2004). *Cultural heritage - Wooden artefacts - Load bearing structures of buildings - On site inspection for the diagnosis of timber members*.
- UNI standard 11138:2004 (2004). *Cultural heritage - Load bearing structures of buildings - Criteria for the preliminary evaluation, design and execution of works*.
- Valluzzi, M.R., Garbin, M., Dalla Benetta, M.R & Modena, C. (2010). *In-plane strengthening of timber floors for the seismic improvement of masonry building*. World Conference on Timber Engineering, WCTE 2010, Riva del Garda, Italy.

Elena Ongaretto

University of Bologna,
Department of Civil,
Chemical, Environmental
and Materials Engineering
Bologna
Italy
elena.ongaretto@unibo.it

Luca Pozza

University of Bologna,
Department of Civil,
Chemical, Environmental
and Materials Engineering
Bologna
Italy
luca.pozza2@unibo.it

Marco Savoia

University of Bologna,
Department of Civil,
Chemical, Environmental
and Materials Engineering
Bologna
Italy
marco.savoia@unibo.it
